



Cerradura Digital YDL120

Digital deadbolt YDL120
Fechadura Digital YDL120









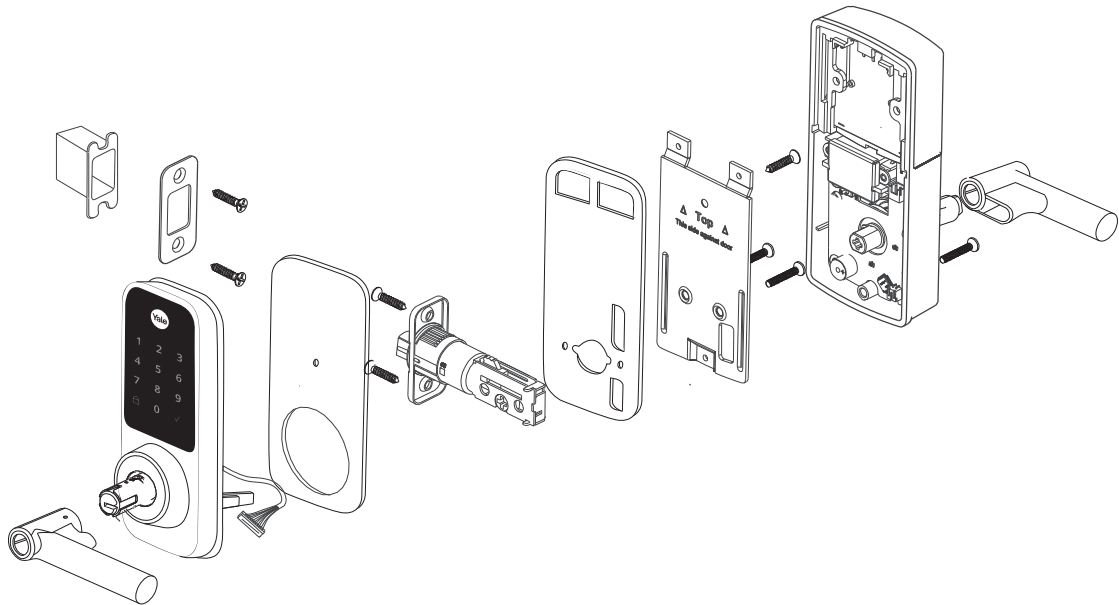







Instructivo de Instalación

Installation Instructions
Instruções de Instalação



 1x Cuerpo Exterior Exterior Escutcheon Corpo Externo	 1x Cuerpo Interior Interior Escutcheon Corpo Interno	 1x Placa de Montaje Mounting Plate Placa de Montagem
 2x Manijas Levers Maçanetas	 1x Orquilla Pin Pino	 2x Empaque de Silicona Silicone Cover Moldura de Silicône
 2x Llaves Keys Chaves	 1x Pestillo Latch Máquina	 1x Pieza Plástica para la Cantonera Strike Box Acabamento Plástico
 1x Cilindro Cylinder Cilindro	 12x Tornillos Screws Parafusos	 4x Baterías Batteries Pilhas
		 1x Contra Door Strike Contra Chapa

HERRAMIENTAS NECESARIAS

TOOLS NEEDED
FERRAMENTAS NECESSÁRIAS

- 
Copa Sierra 25mm y 54mm
 Hole Saw 25mm and 54mm
 Serra Copo 25mm e 54mm
- 
Formón
 Chisel
 Formão
- 
Desarmador de Cruz
 Cross Screwdriver
 Chave Phillips
- 
Taladro
 Drill
 Furadeira
- 
Cinta métrica
 Measuring tape
 Trena

Determina el lado de la puerta

Determine the side of your door
Determine o lado de sua porta

Para verificar el lado de tu puerta, **sitúate fuera de ella.**

If you want to know which side is your door, **stand outside and check.**

Se você quer saber de que lado é sua porta, **fique do lado de fora e verifique.**

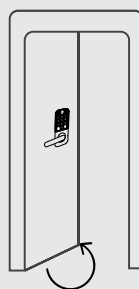

Izquierda
Left
Esquerda

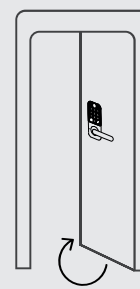

Derecha
Right
Direita

1 Preparación de la Puerta

Preparing Door / Preparação da Porta



NOTA / NOTE: Lee cuidadosamente las instrucciones antes de instalar. No utilices destornillador eléctrico, solo herramientas manuales para no ajustar demasiado los tornillos. Si la puerta ya cuenta con las perforaciones salta el siguiente paso. / Please read the instructions carefully before installing. Don't use an electric screwdriver, just hand tools to avoid over-tightening the screws. If the door already has perforations, skip the next step. / Por favor, leia as instruções cuidadosamente antes de instalar. Não use parafusadeiras elétricas ou a baterias, apenas ferramentas manuais para evitar apertar demais os parafusos. Se a porta já tiver perfurações, pule o próximo passo.

A. Utilizando la plantilla marca los centros de los agujeros a perforar. Se recomienda ubicar el centro de la cerradura de 90 a 100 cm del piso. / Using the template, mark the centers of the holes to be drilled. It is recommended 90 to 100 cm from the floor to the center of the lock. / Utilizando o gabarito, marque os centros dos furos a serem perfurados. Recomenda-se de 90 a 100 cm do piso até o centro da fechadura.

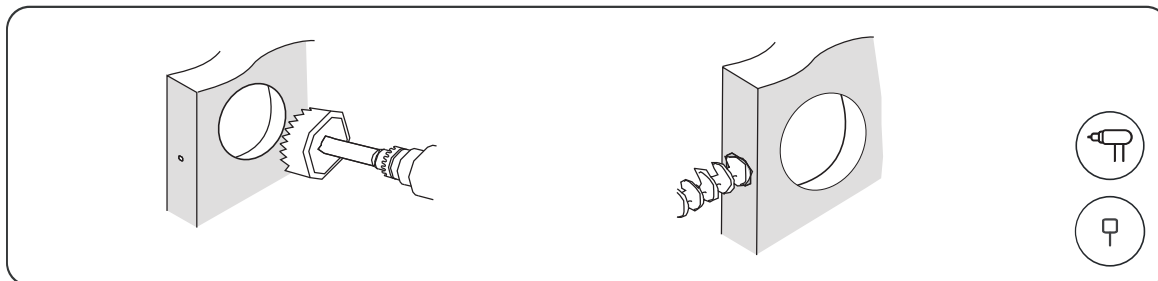
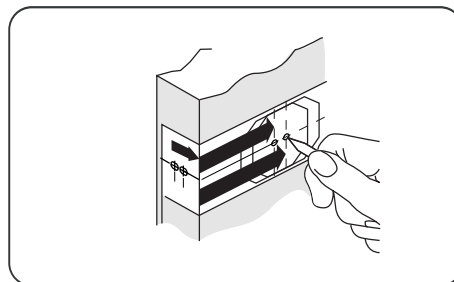

B. Inserta el pestillo por el canto de la puerta y remarca el contorno del frente. Realiza un rebaje en el área demarcada de unos 3 mm de profundidad para alojar la placa frontal. / Insert the latch through the hole in the door edge and draw the outline of the front, groove the entire area 3 mm deep with the chisel where the latch plate will stay. / Insira a máquina através do furo efetuado na borda da porta e desenhe o contorno da frente, rebaise toda a área com 3 mm de profundidade com o formão onde a placa da máquina será alojada.

2 Instalación de la Contra en el Marco

Installation of the Door Strike / Instalação da Contra Chapa

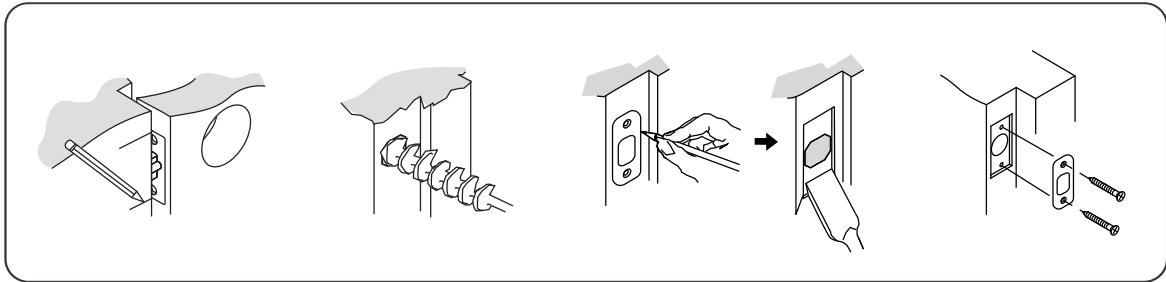

A. Marca la posición de la contra / Mark the position where the door strike will be. / Marque a posição da contra chapa.

B. Perfora un agujero de 25 mm en el marco de la puerta en la posición marcada en A. / Drill a 25 mm (1") hole in the door in the position where A was marked. / Faça um furo de 25 mm no batente da porta na posição marcada A.

C. Remarca el contorno de la contra y realiza un rebaje 3 mm de profundidad, para permitir que ésta quede al ras de la superficie. / Remark the contour of the counter and make a 3 mm deep recess, to allow it to be flush with the surface. / Desenhe o contorno da contra chapa e rebaixe toda a área com 3 mm de profundidade, para permitir que ele fique nivelado com a superfície.

D. Instala la contra en el marco de la puerta usando los tornillos de 20 mm. / Install the strike to the door frame using the 20 mm screws. / Instale a contra chapa no batente da porta usando os parafusos de 20 mm.

3 Ajuste del Pestillo

Latch Adjustment / Ajuste da Máquina

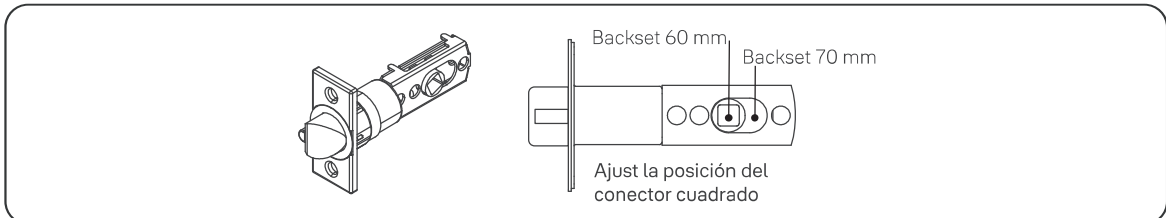

Para ajustar el backset de 60 mm a 70 mm jala y ubica el conector en la posición deseada. / To adjust the backset from 60 mm to 70 mm, pull and place the square connector in the desired position. / Para ajustar o backset de 60 mm a 70 mm, puxe e coloque o cubo na posição desejada.

4 Instalación del Pestillo

Installing the Latch / Instalando a Máquina

A. Inserta el pestillo orientado de acuerdo al lado de tu puerta. / Place the latch according to your door side. / Insira a máquina de acordo com o lado da sua porta.

B. Asegúrate de que la placa frontal quede alineada con el canto de la puerta. Retira el exceso de material si es necesario para un ajuste al ras. / Make sure the front plate is aligned with the door edge. Remove excess material if necessary for a close fit. / Verifique se a chapa da máquina está alinhada com a porta. Remova o excesso de material, se necessário, para um encaixe perfeito.

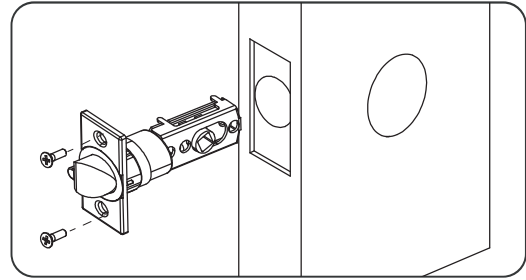

C. Utiliza 2 de los tornillos de 20 mm incluidos, para fijar la placa del pestillo. NO APRIETES DEMASIADO. / Use 2 of the 20 mm screws included to fix the latch plate. DO NOT OVERTIGHTEN. / Use 2 parafusos de 20 mm incluídos para fixar a chapa da máquina. NÃO APERTAR DEMAIS.

5 Montaje de las Manijas

Levers Assembly / Montagem da Maçanetas

Verifica el lado de tu puerta antes de montar las manijas. / Check the side of your door before mounting levers / Por favor, verifique o lado da sua porta antes de montar as maçanetas.

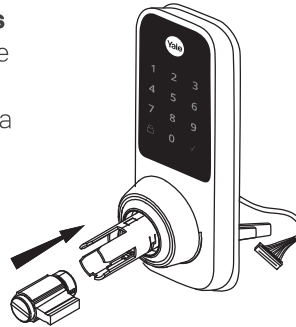

A. Toma cilindro, retíralo del soporte, gíralo y vuelve a insertarlo / Take the cylinder, remove it from the holder, turn it over and reinsert it. / Retire o cilindro do suporte, vire-o e reinsira-o, caso necessário.

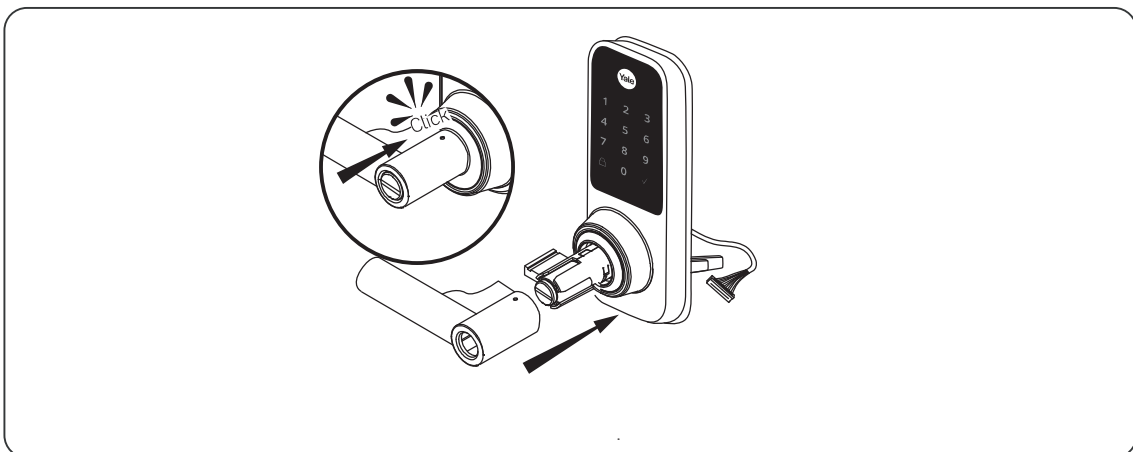

B. Introduce la manija por el soporte del cilindro hasta que enganche mecánicamente / Insert the lever through the cylinder holder until it fix. / Insira a maçaneta através do suporte do cilindro até encaixar.

6 Instalación del Cuerpo Exterior

Exterior Escutcheon Installation / Instalação do Corpo Externo

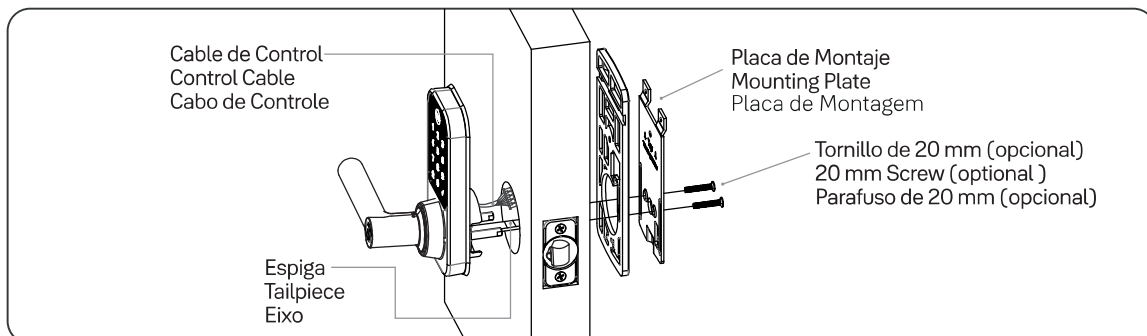

A. Desempaca el cuerpo exterior. Ten cuidado de no rayar la placa de circuito durante la manipulación e instalación. / Unpack the exterior escutcheon. Be careful not to scratch the circuit board during handling and installation. / Desembale o corpo externo. Cuidado para não arranhar a placa de circuito durante o manuseio e a instalação.

B. Verifica que el empaque de silicona este acentado correctamente en el cuerpo exterior / Verify that the silicone cover is settled properly on the outside. / Verifique se a moldura de silicone está encaixada corretamente do lado de fora.

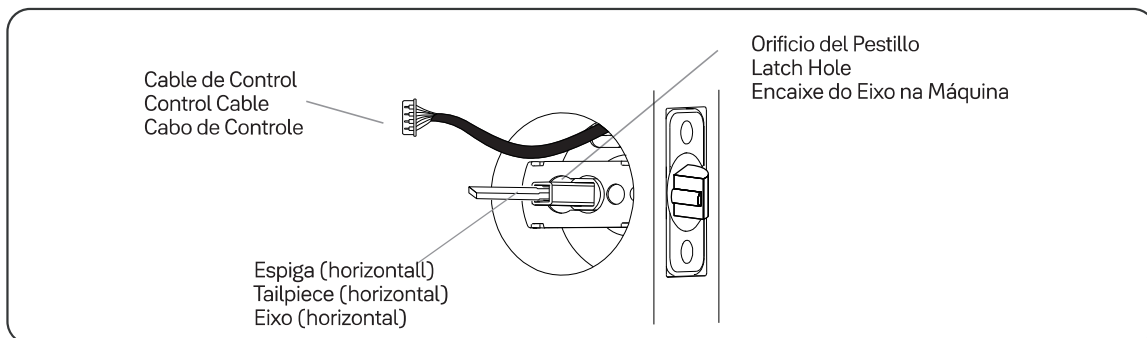

C. Ubica el cuerpo exterior en la puerta, pasando la espiga en forma horizontal a través del pestillo. / Locate the exterior escutcheon on the door, passing the tailpiece in horizontally through the latch. / Coloque o corpo externo na porta, passando o eixo horizontalmente pela máquina.

D. Pasa el cable de control a través de la ranura rectangular de la placa de montaje. / Pass the control cable through the rectangular groove in the mounting plate. / Passe o cabo de controle através do orificio retangular na placa de montagem.

E. Asegura la placa de montaje al cuerpo exterior. Utiliza los tornillos de 23 mm si el grosor de la puerta es de 40 a 45 mm, o los tornillos de 17 mm si el grosor de la puerta es de 30 a 35 mm. Aprieta con un desarmador sin ajustar por completo. / Secure the mounting plate to the exterior escutcheon. Use the 23 mm screws if the door thickness is 40 to 45 mm, or the 17 mm screws if the door thickness is 30 to 35 mm. Tighten with a screwdriver without fully tightening. / Fixe a placa de montagem ao corpo externo usando dois parafusos de 23 mm se a espessura da porta for de 40 a 45 mm; dois parafusos de 17 mm se a espessura da porta for de 30 a 35 mm. Aperte manualmente com uma chave philips sem fixar completamente.

F. Opcionalmente puedes colocar uno de los tornillos de 20 mm provistos, utilizando el orificio superior de la placa de montaje. / Optionally you can fit the 20 mm screw using the top hole of the mounting plate. / Opcionalmente, você pode instalar o parafuso de 20 mm usando o furo superior da placa de montagem.

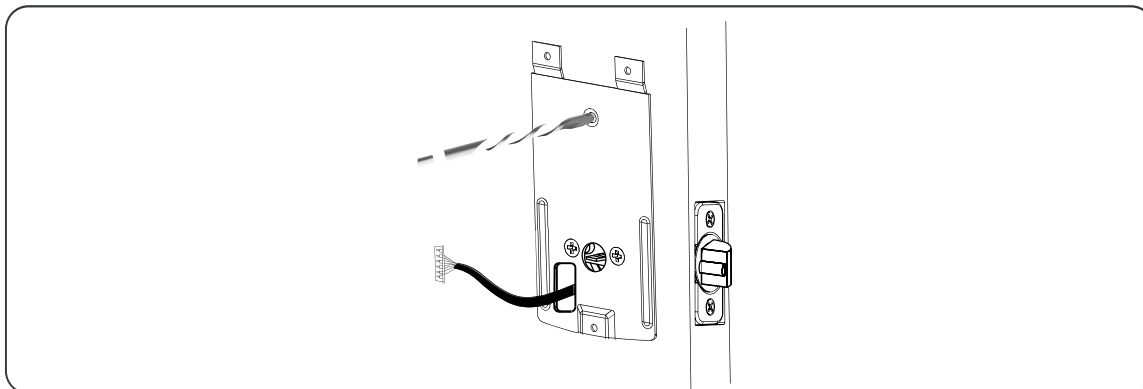

NOTA / NOTE: Utiliza la manija para verificar que el pestillo se desliza fácilmente. / Use the handle to check that the latch slides easily. / Utilize a maçaneta para verificar se a lingueta desliza facilmente.

7 Instalación del Cuerpo Interior

Interior Escutcheon Installation / Instalação do Corpo Interno

Antes de montar el cuerpo interior, coloca la manija siguiendo las indicaciones del punto 5. / Before assembling the inner body, place the lever following the indications in point 5. / Antes de montar o corpo interno, coloque a maçaneta seguindo as indicações no passo 5.

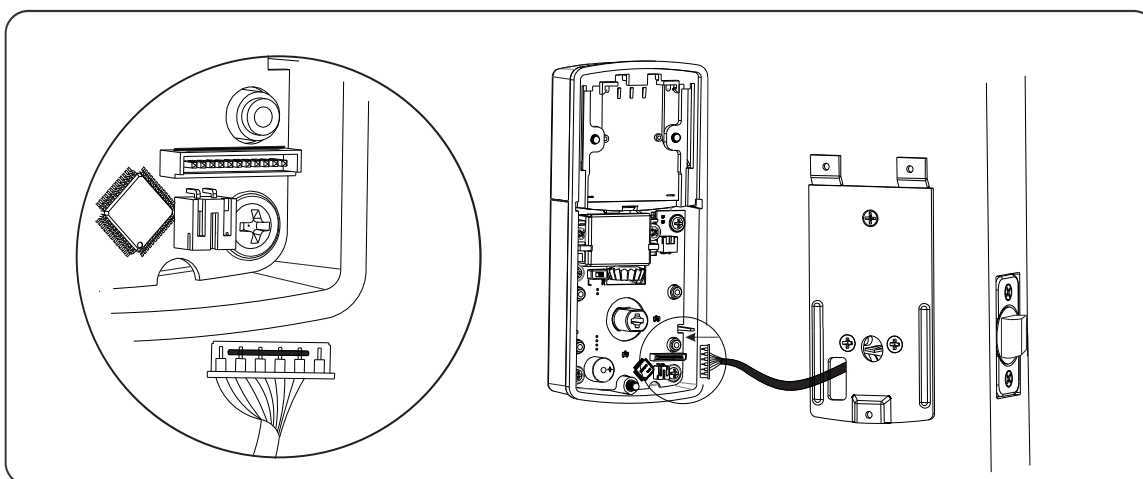

A. Conecta cuidadosamente el enchufe macho con el conector hembra alojado en el cuerpo interior. / Connect carefully the male plug with the female connector housed in the interior escutcheon. / Conecte cuidadosamente o plugue macho com o conector fêmea alojado no corpo interno.

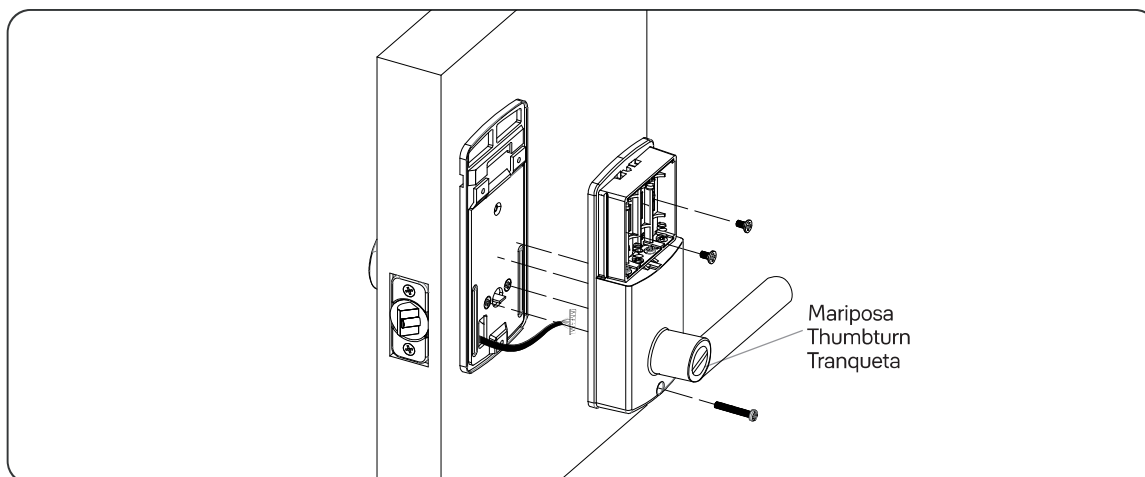

B. Coloca el cuerpo interior montando la espiga en el alojamiento. Esta debe estar en horizontal. / Place the interior escutcheon mounting the tailpiece on the lever. This must be in the correct position for left or right door. / Coloque o corpo interno encaixando o eixo na maçaneta. Esta deve estar na posição correta para a porta esquerda ou direita.

C. Con dos tornillos de 8 mm y un tornillo de 25 mm, fija el cuerpo interior a la placa de montaje. No aprietes demasiado los tornillos. / Using two 8mm screws and one 25 mm screw, attach the interior escutcheon to the mounting plate. Don't overtighten the screws. / Usando dois parafusos de 8 mm e um parafuso de 25 mm, fixe o corpo interno à placa de montagem. Não aperte demais os parafusos.



NOTA / NOTE: Utiliza la manija para verificar que el pestillo abra y cierre fácilmente. / Use the lever to verify that the latch opens and closes easily. / Utilize a maçaneta para verificar se a lingueta abre e fecha livremente.

8 Invertir la Manija

Reverse the Levers / Inverter as Maçanetas

A. Asegúrate que la cerradura esté en posición de apertura y quita la llave. / Make sure that the lock is in open position and remove the key. / Certifique-se de que a fechadura esteja na posição aberta e remova a chave.

B. Presiona y desliza hacia afuera, utilizando la herramienta a través del orificio. Retire la manija. / Press and slide out, using the pin removal through hole. Remove the lever. / Pressione e deslize para fora, usando a ferramenta pino através do orifício. Remova a maçaneta.

C. Retira el cilindro del soporte y colócalo en la nueva posición. / Remove the cylinder from the bracket and place it in the new position. / Remova o cilindro do suporte e coloque-o na nova posição.

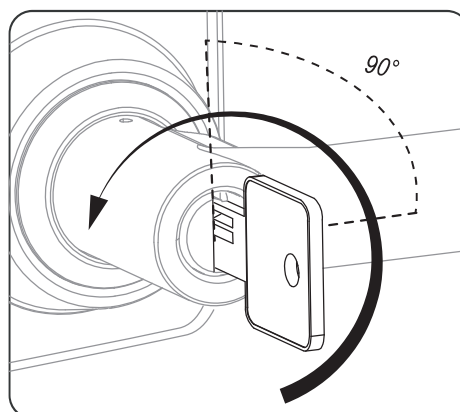

D. Gira la manija con respecto a la posición inicial e introdúcela por el soporte del cilindro hasta que enganche mecánicamente. / Turn the lever to the new position and insert it through the cylinder support

until it engages. / Gire a maçaneta para a nova posição e insira-o através do suporte do cilindro até encaixar.

E. Para modificar la manija del cuerpo interior, repite desde paso B. / To modify the inner lever, repeat from step B. / Para modificar a maçaneta interna, repita a partir do passo B.

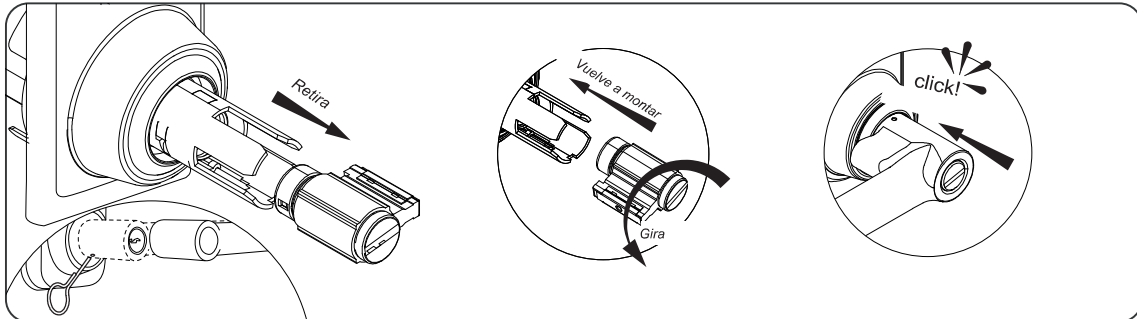

9 Instalación de las Baterías

Battery Installation / Instalação das Pilhas

A. Inserta 4 pilas alcalinas AA en la dirección señalada +/- en el compartimento. La cerradura emitirá 1 beep 2 veces, el teclado se iluminará indicando que recibió energía. / Insert 4 AA alkaline batteries in the direction indicated +/- into the compartment. The lock will emit 1 beep 2 times, the touchscreen will light up indicating it received power. / Coloque 4 pilhas alcalinas AA na direção indicada +/- no compartimento. A fechadura emitirá 2 bipes, o teclado acenderá indicando que recebeu energia.

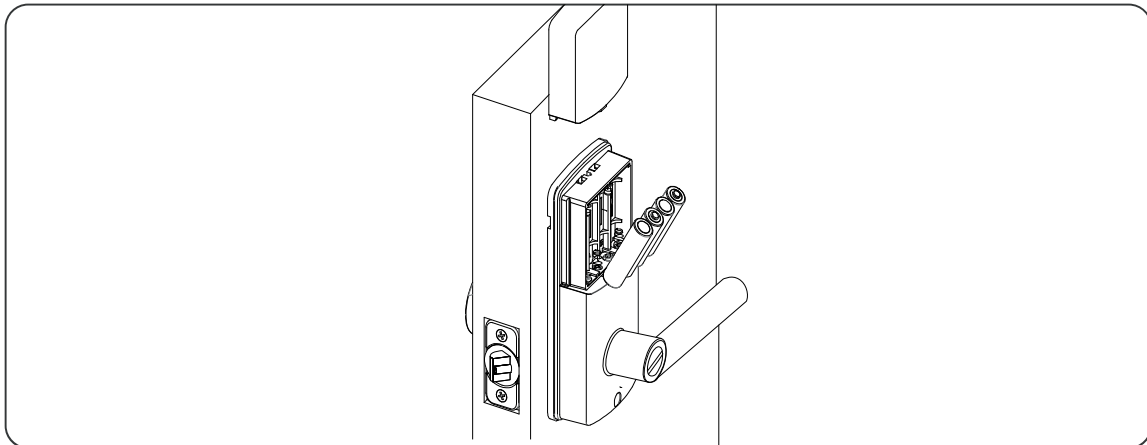

NOTA / NOTE: No toques el teclado hasta que la luz se apague. No uses baterías recargables ni baterías no alcalinas. / Do not touch the keyboard until the light turns off. Do not use rechargeable batteries or non-alkaline batteries. / Não toque o teclado até que a luz apague. Não use pilhas recarregáveis, utilize apenas pilhas alcalinas.

Instrucciones de Programación

Setting Instructions
Instruções de Programação



Activa el Teclado Táctil



Touchscreen Activation / Ativação do Teclado



Para activar el teclado deberás deslizar la palma de tu mano sobre los números. / To activate the touchscreen you will have to slide the palm of your hand over the touchscreen numbers. / Para ativar o teclado, você terá que deslizar a palma da sua mão sobre os números do teclado.





Antes de cualquier configuración debes ingresar el código maestro (PC). El código preestablecido es 123456, luego lo podrás cambiar.

Before any configuration you must enter the master code (PC). The default code is 123456, then you can change it. / Antes de qualquer configuração, você deve inserir o código mestre (PC). O código predefinido é 123456, e você pode alterá-lo.

			
PC	PC es el código maestro, el código preestablecido es 123456.	PC is master code, default code is 123456.	PC é a senha mestre, a senha predefinida é 123456.
UC	UC es el código de usuario, el código preestablecido es 1234. Máximo 50 UC.	UC is user code; default code is 1234. Maximum 50 UC.	UC e a senha de usuário, a senha predefinida é 1234. UC máximo 50.

1 Indicadores de Sonido

Sound Indicators / Definição de Som

	Advertencia de batería baja (menor a 4.8V) sonarán 7 beeps.	Low battery warning (less than 4.8V) 7 beeps will sound.	Aviso de batería fraca (menos de 4,8V) 7 sinais sonoros serão emitidos.
	Configuración correcta: Sonará 1 beep.	Correct setup: 1 beep will sound.	Configuração correta: 1 bipe será emitido.
	Configuración incorrecta: Sonarán 2 beeps.	Wrong setup: 2 beeps will sound.	Configuração incorreta: serão emitidos 2 bipes.
	Proceso de bloqueo incorrecto: Sonarán 3 beeps.	Wrong lock process: 3 beeps will sound.	Processo de bloqueio incorreto: 3 bipes serão emitidos.
	Ingreso de código incorrecto 4 veces, sonarán 2 beeps y el teclado se bloqueará por 60 segundos.	Input Wrong enter 4 times, lock will beep 2 times, touchscreen will be disabled for 60 seconds.	Entrada incorreta de código 4 veces, serão emitidos 2 bipes e o teclado será bloqueado por 60 segundos.

2 Desbloquear el Pestillo

Unlock the Latch / Abrir a Fechadura



Activa el teclado táctil
Activate the touchscreen
Ativar o teclado digital



Ingresa un UC correcto y presiona ✓
Enter a correct UC and press ✓
Inserir senha de usuário (UC) e pressione ✓



La cerradura emitirá 1 beep y el pestillo se retraerá
Lock will beep one time and bolt will retract
A fechadura emitirá um bipe e poderá abrir através da maçaneta externa.

3 Bloquear el Pestillo

Lock the Latch / Trancar a Fechadura

-  Activa el teclado táctil
Activate the touchscreen >
Ativar o teclado digital
-  Presiona
Press >
Pressione
-  La cerradura emitirá 2 beeps y el pestillo se cerrará
Lock will beep 2 times and latch will deadlock
A fechadura emitirá 2 bipes a lingueta será bloqueada pela maçaneta externa.

4 Crear nuevo Código de Usuario (UC)

Create a New User Code (UC) / Criando o Código do Usuário (UC)

Se pueden crear hasta 50 códigos de usuarios, el ID de UC es de 01 a 50, el código de usuario predeterminado de fábrica se deshabilitará después de crear un nuevo UC.

Up to 50 user codes can be created, the UC ID is 01 to 50, the factory default user code will be disabled after creating a new UC. / Podem ser criados até 50 senhas de usuários a identificação (ID) das senhas de usuários (UC) é de 01 a 50, o código de usuário padrão de fábrica será desativado após a criação de uma nova senha de usuário (UC).

Configuración Modo A o Modo B







Configuration Mode A or Mode B / Modo de Configuração A o Modo B

Modo A: Sigue estos pasos si deseas asociar el código UC a una posición, así cuando requieras borrarlo no necesitarás el UC sino la posición dónde fue almacenado. /







Follow these steps if you want to associate the UC code with a position, so when you need to delete it you will not need the UC, but the position where it was stored. / Siga estas etapas se desejar asociar a senha de usuário (UC) a uma posição; portanto, quando precisar excluí-la, não será necessário a senha de usuário (UC), mas a posição em que foi armazenada.

Modo B: Configura UC sin asociarlo a una posición. Necesitarás saber la clave de usuario para poder borrarlo. / Configure UC without associating it to a position. You will need to know the user code to be able to delete it. / Configurar a senha de usuário (UC) sem associá-la a uma posição. Você precisará saber a senha do usuário para poder excluí-la.

A

-  Activa el teclado táctil
Activate the touchscreen >
Ativar o teclado digital
-  Ingresas el PC y presiona ✓
Enter PC and press ✓ >
Digite PC e pressione ✓
-  Presiona 1 y presiona ✓
Press 1 and press ✓ >
Pressione 1 e pressione ✓
-  Ingresas el ID del 01 al 50 y presiona ✓
Enter ID 01-50 and press ✓ >
Digite o ID de 01 a 50 e pressione ✓
-  Ingresas el nuevo UC (4 a 8 dígitos) y presiona ✓
Enter new UC (4 to 8 digits) and press ✓ >
Digite o novo UC (4-8 dígitos) e pressione ✓
-  Repite el nuevo UC y presiona ✓
Repeat new UC and press ✓ >
Repita o novo UC e pressione ✓
-  La cerradura emitirá 1 beep
Lock will beep one time
A fechadura emitirá 1 bipe

B

-  Activa el teclado táctil
Activate the touchscreen >
Ativar o teclado digital
-  Ingresas el PC y presiona ✓
Enter PC and press ✓ >
Digite PC e pressione ✓
-  Presiona 1 y presiona ✓
Press 1 and press ✓ >
Pressione 1 e pressione ✓
-  Ingresas el nuevo UC (4 a 8 dígitos) y presiona ✓
Enter new UC (4 to 8 digits) and press ✓ >
Digite o novo UC (4-8 dígitos) e pressione ✓
-  Repite el nuevo UC y presiona ✓
Repeat new UC and press ✓ >
Repita o novo UC e pressione ✓
-  La cerradura emitirá 1 beep
Lock will beep one time
A fechadura emitirá 1 bipe

Puedes continuar creando más UC en 10 segundos después del beep sin repetir el proceso anterior. Sal sin operar en 10 segundos después del beep, o presiona el ícono de bloqueo. / You can continue creating more UC in 10 seconds after the beep



without repeating the previous process. Exit without operating within 10 seconds after the beep, or press the lock icon. / O usuário pode continuar criando mais UC em 10 segundos após o sinal sonoro, sem repetir o processo anterior. Para sair, não pressione nenhuma tecla por 10 segundos após o beep ou pressione a tecla de bloqueio.



5 Eliminar Código de Usuario (UC)

Eliminate a New User Code (UC) / Excluir Senha de Usuário (UC)



Ten en cuenta la configuración Modo A o Modo B. / Take into account Mode A and Mode B configuration. / Leve em consideração a configuração do Modo A ou do Modo B.



A

 Activa el teclado táctil >  Ingresar el PC y presionar ✓ >  Presionar 2 y presionar ✓
 Activate the touchscreen > Enter PC and press ✓ > Press 2 and press ✓
 Ativar o teclado digital > Digite PC e pressione ✓ > Pressione 2 e pressione ✓

 Ingresar el ID del 01 al 50 y presionar ✓ >  Repetir el nuevo ID Presionar ✓ >  La cerradura emitirá 1 beep
 Enter ID (01-50) and press ✓ > Repeat new ID Press ✓ > Lock will beep one time
 Digite o ID de 01 a 50 e pressione ✓ > Digite novamente o ID e pressione ✓ > A fechadura emitirá 1 bipe



B



 Activa el teclado táctil >  Ingresar el PC y presionar ✓ >  Presionar 2 y presionar ✓
 Activate the touchscreen > Enter PC and press ✓ > Press 2 and press ✓
 Ativar o teclado digital > Digite PC e pressione ✓ > Pressione 2 e pressione ✓

 Ingresar el UC y presionar ✓ >  Repetir el nuevo UC y presionar ✓ >  La cerradura emitirá 1 beep
 Enter UC and press ✓ > Repeat new UC and press ✓ > Lock will beep one time
 Digite UC e pressione ✓ > Digite novamente o UC e pressione ✓ > A fechadura emitirá 1 bipe

6 Eliminar todos los Códigos de Usuario (UC)

Eliminate all User Codes (UC) / Excluir todos os Códigos de Usuário (UC)

 Activa el teclado táctil >  Ingresar el PC y presionar ✓ >  Presionar 3 y presionar ✓
 Activate the touchscreen > Enter PC and press ✓ > Press 3 and press ✓
 Ativar o teclado digital > Digite PC e pressione ✓ > Pressione 3 e pressione ✓



 Repetir el PC y presionar ✓ (Eliminar todas las UC excepto PC) >  La cerradura emitirá 1 beep
 Repeat PC and Press ✓ (Eliminate all UC except PC) > Lock will beep one time
 Digite novamente o PC e Pressione ✓ (Excluir todos UC, exceto PC) > A fechadura emitirá 1 bipe



7 Cambiar Código Maestro (PC)

Change Master Code (PC) / Alterar Senha Mestre (PC)

Recuerda que el PC preestablecido es 123456.

Remember that the default PC is 123456. / Lembre-se de que o PC predefinido é 123456.

 Activa el teclado táctil >  Ingresar el PC y presionar ✓ >  Presionar 4 y presionar ✓
 Activate the touchscreen > Enter PC and press ✓ > Press 4 and press ✓
 Ativar o teclado digital > Digite PC e pressione ✓ > Pressione 4 e pressione ✓





 Ingresar el PC (4 a 8 dígitos) y presionar ✓ >  Repetir el nuevo PC >  La cerradura emitirá 1 beep
 Enter PC (4 to 8 digits) and press ✓ > Repeat new PC > Lock will beep one time
 Digite novo PC (4-8 dígitos) e pressione ✓ > Repita o novo PC > A fechadura emitirá 1 bipe

8 Cierre Automático

Auto Lock / Trancamento Automático

Esta función te permite configurar el bloqueo del pestillo automáticamente luego de un tiempo definido.

This feature allows you to set the latch lock automatically after a defined time. / Esse recurso permite definir o trancamento automático da fechadura após um tempo definido.







-  Activa el teclado táctil
Activate the touchscreen
Ativar o teclado digital
- >
-  Ingresa el PC y presiona ✓
Enter PC and press ✓
Digite PC e pressione ✓
- >
-  Presiona 5 y presiona ✓
Press 5 and press ✓
Pressione 5 e pressione ✓
- >
-  Ingresa tiempo (20 a 900s) y presiona ✓
Enter time (20 to 900s) and press ✓
Digite o tempo desejado (20 a 900s) pressione ✓
- >
-  La cerradura emitirá 1 beep
Lock will beep one time
A fechadura emitirá 1 bipe

9 Modo Silencioso

Silent Mode / Modo Silencioso

Esta función te permite desactivar los indicadores de sonido.

This feature allows you to disable the sound indicators. / Esse recurso permite desativar os indicadores sonoros.

-  Activa el teclado táctil
Activate the touchscreen
Ativar o teclado digital
- >
-  Ingresa el PC y presiona ✓
Enter PC and press ✓
Digite PC e pressione ✓
- >
-  Presiona 6 y presiona ✓
Press 6 and press ✓
Pressione 6 e pressione ✓
- >
-  Presiona 1 para activar y presiona ✓
Press 1 to activate and press ✓
Pressione 1 para ativar e pressione ✓
- >
-  Presiona 2 para desactivar y presiona ✓
Press 2 to disable and press ✓
Pressione 2 para desativar e pressione ✓
- >
-  La cerradura emitirá 1 beep
Lock will beep one time
A fechadura emitirá 1 bipe

10 Modo Vacaciones





Vacation Mode / Modo Férias

Esta función permite reducir el consumo de baterías.

This function allows to reduce the batteries consumption. / Esta função permite reduzir o consumo das pilhas.





Activar Modo Vacaciones

Vacation Mode / Ativar Modo Férias

-  Activa el teclado táctil
Activate the touchscreen
Ativar o teclado digital
- >
-  Ingresa el PC y presiona ✓
Enter PC and press ✓
Digite PC e pressione ✓
- >
-  Presiona 10 y presiona ✓
Press 10 and press ✓
Pressione 10 e pressione ✓
- >
-  Presiona 1 y presiona ✓
Press 1 and press ✓
Pressione 1 e pressione ✓
- >
-  La cerradura emitirá 1 beep, presiona el ícono de bloqueo o se bloqueará automáticamente
Lock will beep one time – press lock icon or it'll lock automatically
A fechadura emitirá 1 bipe, pressione a tecla de bloqueio ou a fechadura irá trancar automaticamente

Desactivar Modo Vacaciones

Disable Vacation Mode / Desativar Modo Férias





-  Presiona ✓ durante 3 s
Press ✓ over 3 s
Pressione ✓ durante 3 s >
-  Suelta ✓ cuando la luz de la pantalla se encienda
Release ✓ when backlight is on
Solte ✓ quando a luz do teclado acender >
-  Ingresa el PC y presiona ✓
Enter PC and press ✓
Digite PC e pressione ✓ >
-  La cerradura emitirá 1 beep, el pestillo se retraerá
Lock will beep one time - latch will retract
A fechadura emitirá 1 bipe, a lingueta irá retrair

11 Restablecer Parámetros de Fábrica

Factory Default / Restauração de Fábrica

Al restablecer los parámetros de fábrica, todos los UC creados con anterioridad se habrán borrado. Se vuelve a los código preestablecidos: PC 123456 y UC 1234.

After factory reset, PC is 123456, UC is 1234, other UCs are cleared, and PC will be 123456 and UC 1234. / Após a redefinição de fábrica, o PC será 123456, UC será 1234 e todos os códigos de usuário inseridos anteriormente serão apagados.

-  Retira las baterías y espera 10 s
Remove batteries and wait over 10 s
Retire as pilhas e guarde 10 s >
-  Inserta las baterías nuevamente
Insert batteries again
Coloque as pilhas novamente >
-  La cerradura emitirá 2 beeps
The door lock will emit 2 beeps
A fechadura emitirá 2 bipes >
-  Presiona el ícono de bloqueo tres veces en 3 s
Press lock icon three times in 3 s
Pressione a tecla de bloqueio três vezes em 3 s >
-  La cerradura emitirá 1 beep
Lock will beep one time
A fechadura emitirá 1 bipe

12 Alimentación de Emergencia

Emergency Power / Alimentação de Emergência

En casos de emergencia, el conector micro USB ubicado en el cuerpo exterior permite alimentar tu cerradura con una fuente externa de 5V-1A e ingresar un código de usuario válido para desbloquear el pestillo.

For emergencies, the micro USB connector located on the external escutcheon allows you to power your lock from an external 5V-1A source and enter a valid user code to unlock the latch. / Em caso de emergência, o conector micro USB localizado na parte externa da fechadura permite que você alimente a fechadura através uma fonte externa, possibilitando que seja inserida uma senha de usuário válida, destrancando a fechadura.

Plantilla de Instalación

Installation Template / Gabarito de Instalação

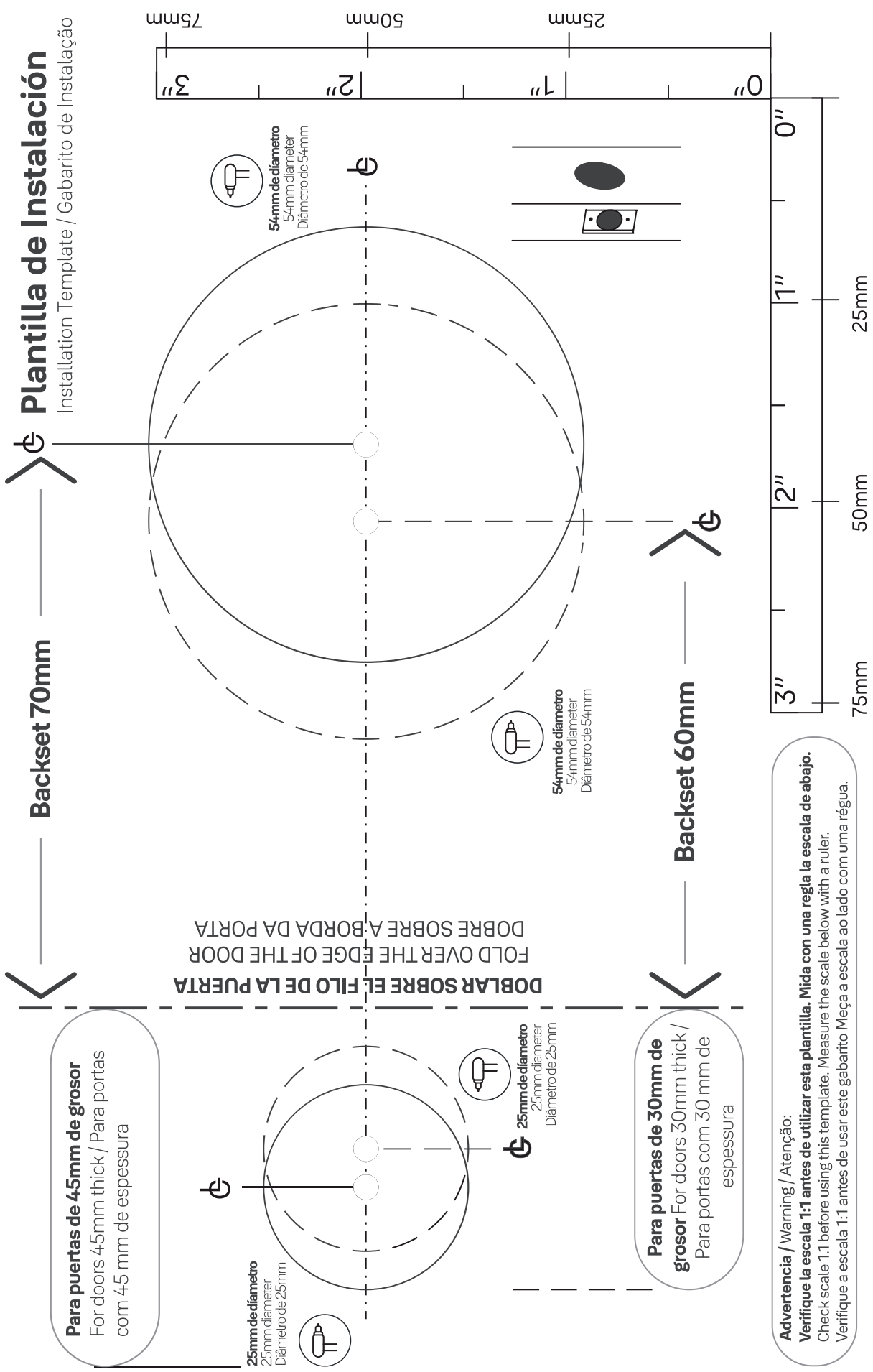

Backset 70mm

Backset 60mm

Para puertas de 45mm de grosor

For doors 45mm thick / Para portas com 45 mm de espessura

Para puertas de 30mm de grosor

For doors 30mm thick / Para portas com 30 mm de espessura

DOBLAR SOBRE EL FILO DE LA PUERTA
DOBRE SOBRE A BORDA DA PORTA
FOLD OVER THE EDGE OF THE DOOR

25mm de diámetro
25mm diameter
Diámetro de 25mm

25mm de diámetro
25mm diameter
Diámetro de 25mm

54mm de diámetro
54mm diameter
Diámetro de 54mm

54mm de diámetro
54mm diameter
Diámetro de 54mm

Advertencia / Warning / Atenção:
Verifique la escala 1:1 antes de utilizar esta plantilla. Mida con una regla la escala de abajo.
Check scale 1:1 before using this template. Measure the scale below with a ruler.
Verifique a escala 1:1 antes de usar este gabarito. Meça a escala ao lado com uma régua.



www.yalelatinoamerica.com - www.yalehome.com.gt - www.yalehome.com.pe
www.yalehome.com.co - www.yalehome.com.mx - www.yalehome.com.br
www.yalechile.cl